USER MANUAL

**MODEL NUMBER:
FI-CN-15N
FI-CN-15NK
FI-CN-15NV
AND RELATED UNITS**

**15 Gallon Air Operated Portable Foam
Unit for Concentrate Products**

English (Original Instructions)

READ ALL INSTRUCTIONS BEFORE OPERATING EQUIPMENT

WARNING



Read this manual completely and understand the machine before operating or servicing it.

- Read all instructions before installing or operating unit.
- Always wear appropriate personal protective equipment (PPE) when operating or servicing unit.
- Always follow all chemical safety precautions and handling instructions provided by the chemical manufacturer and Material Safety Data Sheet (MSDS).
- If this unit is modified or serviced with parts not listed in this manual, dilution rates may vary, or the unit may not operate correctly.
- Never point the discharge wand at yourself, another person, or any object you do not want covered in chemical.
- Always depressurize unit after use (as described in the After Use Instructions). Always store unit depressurized, with the discharge ball valve in the closed position.
- Do not exceed an incoming air pressure of 100 psi (7 bar).
- Do not exceed a fluid temperature of 100°F (37°C).
- Always flush the unit with fresh water for 5 minutes when switching from an alkaline to an acid or an acid to an alkaline.
- Only use clean and dry air. Air must be filtered and free of moisture or pump life will be diminished. If needed, install a water separator (WS-20CFM) before the unit.
- Do not use an air lubricator before the unit.

PROTECT THE ENVIRONMENT

Please dispose of packaging materials, old machine components, and hazardous fluids in an environmentally safe way according to local waste disposal regulations.



Always remember to recycle.

*Specifications and parts are subject to change without notice.

Specifications:

Hose 30 feet reinforced hose, 3/4 inch inside diameter
(9 meters reinforced hose, 19 mm inside diameter)
Foam Output..... 20 to 45 gallons/minute
(75 to 170 liters/minute)
Foaming Distance 25 to 30 feet (7 to 9 meters)

Dimensions:

Length 28 in (711 mm) approximately
Width 19 in (483 mm) approximately
Height 35 in (889 mm) approximately
Weight, including discharge hose and wand:
(Empty) 70 lbs (31.6 kg) approximately

Requirements:

Compressed Air Pressure Requirements: Air regulator (R25) is factory set at 50 psi (3.4 bar). Operating range is 40 to 80 psi (3 to 5 bar) with 5 to 10 CFM (141.6 to 283.3 l/min).

Liquid Temperature 40°F to 100°F (4.4°C to 37°C)

Chemical Requirements: Follow all instructions from chemical manufacturer and Material Safety Data Sheet (MSDS).

Air Operated Double Diaphragm Pump Models Offered:

P56: Polypropylene body with Santoprene diaphragm

P56V: Polypropylene body with Viton diaphragm

P56K: Polypropylene body with Kalrez diaphragm

Acceptable Products:

Alkaline cleaners, Caustic cleaners, Sanitizers, and Acids

* D-Limonene may only be used with Kalrez pump

* Chlorine may only be used with Viton or Kalrez pump

DO NOT USE: All hydrocarbons

READ ALL INSTRUCTIONS BEFORE OPERATING EQUIPMENT

Operation Instructions:

1. Verify that the drain plug (DP) is securely closed.
2. Fill the tank with water.
3. Open the unit back plate. Insert the proper metering tip and connect the chemical intake line to the injector inlet barb (P203CT).
Note: Use the included metering tip color chart to determine the appropriate metering tip based on the product and dilution rate you will be using.
4. Follow all instructions from chemical manufacturer. Fill the chemical container with chemical concentrate.
Note: The unit can hold two FILL-iT chemical jugs (for example, the J2.5BKS - 2.5 gallon jug with suction fittings), one 5 gallon bucket, or another compatible container.
5. Connect the chemical intake line to the chemical container.
6. Verify that the valve (PVCV34FM) at the base of the suction line is open, to allow fluid into the suction line.
7. With the discharge ball valve (HV60) in the closed position, plug an air line into the air fitting (AP25).
8. Slowly open the discharge ball valve (HV60) to begin foaming. The discharge ball valve (HV60) should be completely open while foaming.
9. While the unit is running and discharging product, adjust the needle valve (NV14Y) as needed to regulate the wetness or dryness of the foam following the steps below:
 - a. Close needle valve completely in clockwise direction.
 - b. Open needle valve in counter-clockwise direction 3 complete turns.
 - c. Continue to open needle valve in ¼ turn increments, allowing 30 seconds between adjustments, until desired consistency of foam is achieved.
10. Close the discharge ball valve (HV60) to stop foaming.

Metering Tip Color	Ounces/Gallon (oz/gal)	Ratios
Turquoise	0.40	320-1
Pink	0.80	160-1
Light Blue	0.95	135-1
Brown	1.30	98-1
Red	1.40	92-1
White	1.85	69-1
Green	1.90	67-1
Blue	2.65	48-1
Yellow	2.95	43-1
Black	4.80	27-1
Purple	6.40	20-1
Gray	6.80	19-1
No Tip	9.20	14-1

Injection rate based on:

- Chemical viscosity of 1 cp (water viscosity = 1 cp)
- Internal air regulator pressure setting of 50 psi (3.4 bar)
- Medium foam consistency

Injection rates will vary if above settings are not used.

After Use Instructions:

1. Disconnect the chemical intake line from the chemical container and connect it to a container of clean water. Make sure that the unit tank still contains water.
2. Activate the unit and allow it to run for 2-4 minutes, or until all chemical has been flushed from the system.
3. Disconnect the air line from the air fitting (AP25).
4. Open the discharge ball valve (HV60) to relieve any pressure remaining in the system.
5. Close the ball valve (HV60) after all pressure has been relieved from the system. Store the unit with the discharge ball valve (HV60) in the closed position.

READ ALL INSTRUCTIONS BEFORE OPERATING EQUIPMENT

Maintenance Instructions:

To keep your foam unit operating properly, periodically perform the following maintenance procedures:

Note: Before performing any maintenance, ensure that the unit has been disconnected from the air and water supply and depressurized according to the "After Use Instructions."

- Inspect the pump (P56/P56K/P56V) for wear and leaks.
- Inspect all hoses for leaks or excessive wear. Make sure all hose clamps are in good condition and properly secured.
- Replace the filter (AFR25) located within the air regulator (R25) as needed. Clean by unthreading the air regulator bowl (ABR25) from the air regulator (R25).
- Check the chemical metering tip, suction line and strainer for debris and clean as needed.
- Drain your air compressor tank on a regular basis to help extend pump life. An air source with a high moisture content will accelerate pump wear. Note: If your air source has a high moisture content, you may wish to install a water separator (WS-20CFM) before the unit.

Troubleshooting Instructions:

- Check to ensure that the discharge hose is uncoiled properly, and that there are no kinks that could obstruct fluid flow.
- Check the air regulator bowl (ABR25) and air filter (AFR25) for debris such as water, oil, or rust particles. Clean by unthreading the air regulator bowl (ABR25) from the air regulator (R25).
- If the needle valve (NV14Y) is open too far, the pump (P56/P56K/P56V) may cycle improperly due to lack of air pressure. If this occurs, close and readjust the needle valve (NV14Y) as described in the "Operation Instructions."
- Make sure proper foaming chemical and concentration are being used.
- If air passes through the pump (P56/P56K/P56V) without cycling, the pump needs to be replaced.
- If solution backs up into the air regulator bowl (ABR25), the check valve (CV38) needs to be replaced.
- If foam comes out wet, no matter where the needle valve (NV14Y) is positioned, the check valve (CV38) may need to be replaced.
- Check for proper air pressure on the air gauge (AG100). The air regulator (R25) is factory set at 50 psi (3.4 bar). Operating range is 40 to 80 psi (3 to 5 bar) with 5 to 10 CFM (141.6 to 283.3 l/min).
- If the unit operates at a reduced pressure:
 - o Check the air compressor supplying the unit. If the

pressure is less than 40 psi, turn the unit off until the compressor can catch up.

- o If the air supply is 50 psi (3.4 bar) or above, check the air gauge (AG100), which should read near 50 psi (3.4 bar). If the air gauge reads more or less than 50 psi (3.4 bar), adjust the pressure by turning the knob on the top of the air regulator (R25).
- o If both of the above are okay, the stainless steel mixing mesh (SS-MESH) could be plugged. Remove and clean it by following the instructions below:
 1. Be sure the foam unit is not plugged into an air supply and be sure to relieve all stored pressure in the unit by having the ball valve (HV60) in the open position.
 2. Remove the stainless adaptor (SSA12) from the tee fitting (SST12HB38).
 3. Remove the screen and the mixing mesh from inside the tee fitting (SST12HB38).
 4. Clean any particles from the mixing mesh and the screen.
 5. Replace the mixing mesh and then the screen into the back of the tee and screw the stainless adaptor back into the tee. It is recommended to use a pipe thread sealant when reinstalling the stainless adaptor back into the tee fitting (SST12HB38). If the mixing mesh has a lot of foreign particles in it, make sure the strainer (STR38-IL) is still in place.
- Check the chemical metering tip, suction line and strainer for debris or damage. Clean or replace as needed. To prevent damage to the unit, the strainer must always be used.

READ ALL INSTRUCTIONS BEFORE OPERATING EQUIPMENT

TANK ASSEMBLY

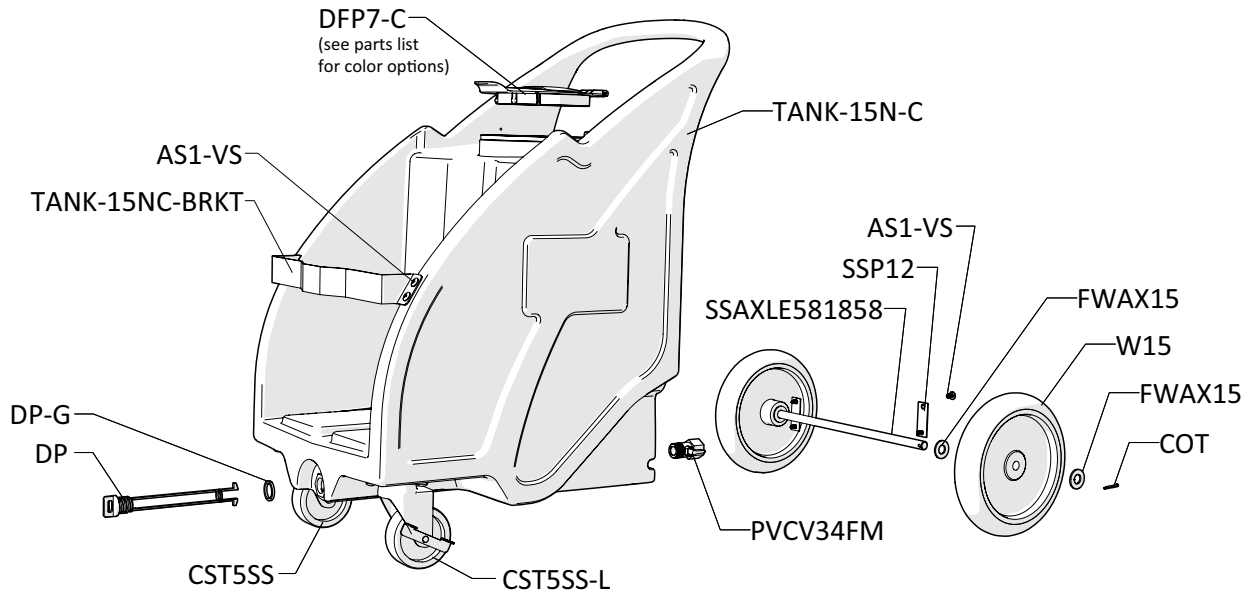

**HOSE AND WAND ASSEMBLY
ITEM NUMBER: SSWA38-HA30**

30 ft (9 m) HOSE ASSEMBLY
ITEM NUMBER: H34-30



ZERO TIP FOAM WAND ASSEMBLY
ITEM NUMBER: SSWA38

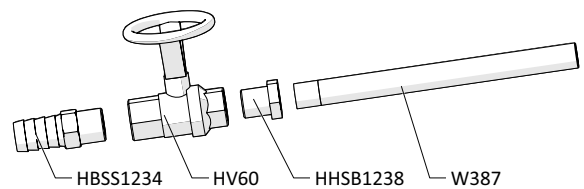

**ANTI-KINK SPRING WITH RETAINING PIN
ITEM NUMBER: AKSS34**

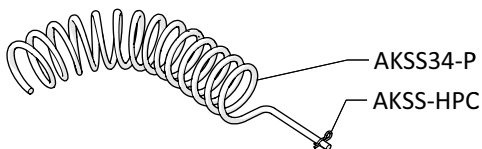

**FAN TIP FOAM WAND ASSEMBLY
ITEM NUMBER: PWA34-ST**

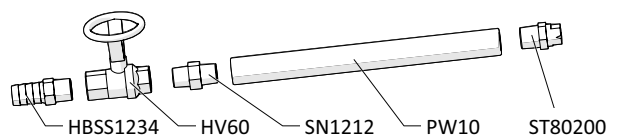

READ ALL INSTRUCTIONS BEFORE OPERATING EQUIPMENT

BACK PLATE ASSEMBLY Inside View

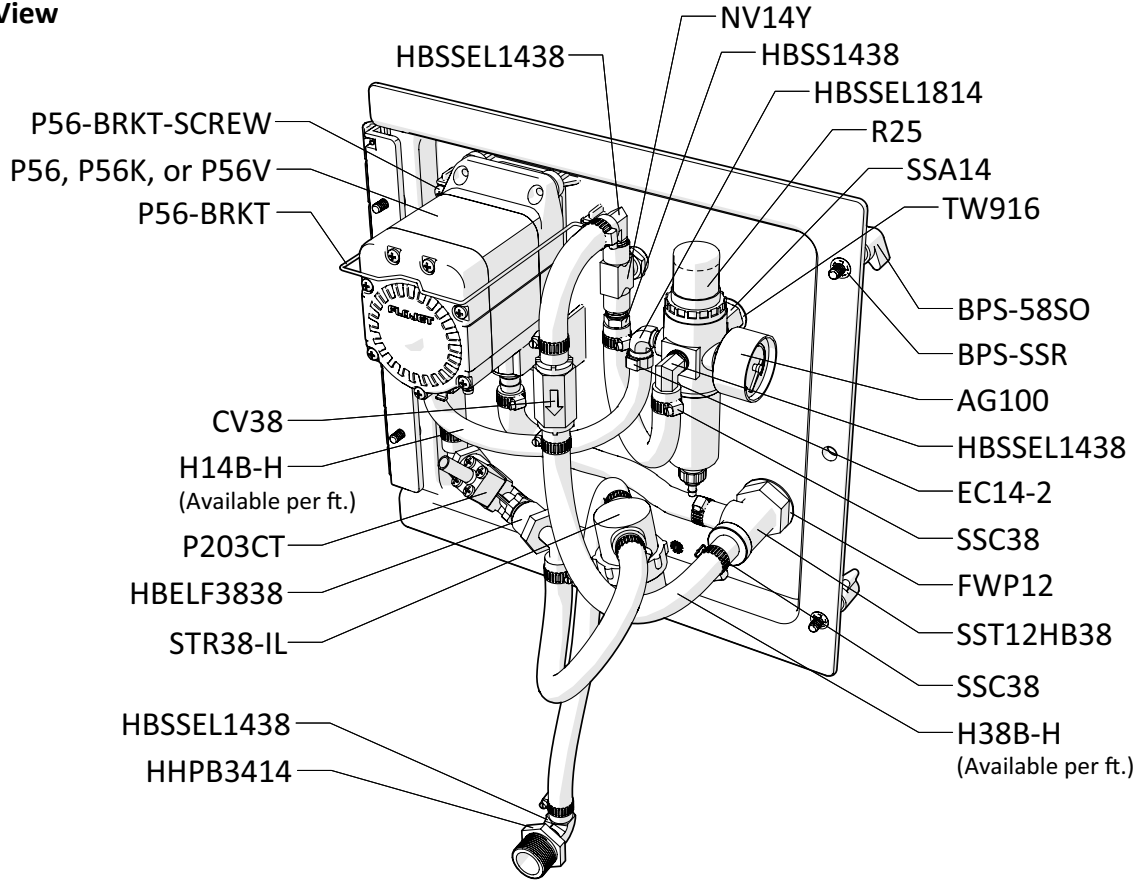

BACK PLATE ASSEMBLY Outside View

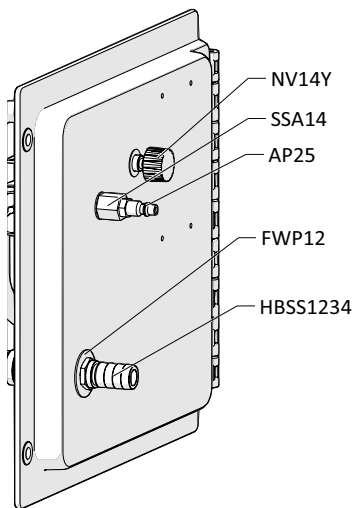

OPTIONAL COMPONENTS

WATER SEPARATOR
ITEM NUMBER: WS-20CFM

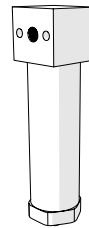

30 ft (9 m) AIR HOSE ASSEMBLY
ITEM NUMBER: AH30

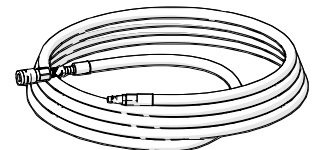

READ ALL INSTRUCTIONS BEFORE OPERATING EQUIPMENT

ITEM NUMBER	DESCRIPTION
AG100	1.5 INCH DRY MODEL 20 DUAL SCALE GAUGE
AKSS34	SS Anti-Kink spring for 3/4 inch hose WITH PIN
AKSS34-P	SS Anti-Kink spring for 3/4 inch hose
AKSS-HPC	ANTI-KINK STAINLESS STEEL HITCH PIN CLIP
AP25	PLUG 1/4 NPTM AIR FITTING - BRASS
AS1-VS	1/4-20 X 1/2 PHIL TRUSS MACH SCREW 19-8 W/516 ORANGE VIBRASEAL PATCH
B8X58	8-15 X 5/8 inch PHIL FLAT TY-A 316 S.S.
BPS-58SO	Back Panel Screw - 5/8 inch with Stand Off
BPS-SSR	1/4 INCH PUSHNUT BOLT RETAINER STAINLESS STEEL
COT	1/8 X 1 COTTER PIN 18-8 S/S
CST5SS	5in S.S. SWIVEL CASTER WITH 4 IN WHEEL
CST5SS-L	5in S.S. SWIVEL CASTER WITH 4 IN WHEEL AND LOCK
CV38	PVC CHECK VALVE 3/8 BARBS - SS SPRING
DFP7	7 INCH HINGED CAP ASSEMBLY - INCLUDES BLACK CAP, LID FLANGE AND HINGE PIN
DFP7-C	7 INCH FILL CAP POLYPRO BLACK
DFP7-F	7 INCH TANK LID FLANGE POLYPRO
DFP7-PIN	HINGE PIN FOR DFP7-C & DFP7-C
DFP7-C-BL	7 INCH FILL CAP POLYPRO BLUE PANTONE
DFP7-C-GN	7 INCH FILL CAP POLYPRO GREEN PANTONE
DFP7-C-RD	7 INCH FILL CAP POLYPRO RED PANTONE
DFP7-C-YL	7 INCH FILL CAP POLYPRO YELLOW PANTONE
DP-A	DRAIN PLUG ASSEMBLY FOR NATURAL PORTABLE UNITS
DP	FRONT DRAIN PLUG FOR PORTABLE UNIT POLYPRO
DP-G	FKM LATHE CUT 60 DUROMETER FKM
DP-INSERT	304 STAINLESS DRAIN PLUG INSERT
EC14-2	OETIKER CLAMP 13.8
F34SS-L	SS CRIMP FERRULE 1.90inches X 1.5 inches LONG
FW14	1/4 X 5/8 OD FLAT WASHER 18-8 PLN
FWAX15	FLAT AXLE WASHER
FWP12	7/8 ID X 1.5 OD X 0.05 THK SSFW
H14B-H	1/4 INCH BLUE HOSE- GOODYEAR HORIZON - Available per ft.
H34B-H	3/4 INCH BLUE GOODYEAR HORIZON HOSE - Available per ft.
H38B-H	3/8 INCH BLUE GOODYEAR HORIZON HOSE - Available per ft.
HBELF3838	HOSE BARB ELBOW 3/8" BY FPT 3/8"
HBSS1234	STAINLESS HOSE BARB 1/2 X 3/4
HBSS1438	STAINLESS HOSE BARB 1/4 MPT X 3/8 BARB
HBSSSEL1438	STAINLESS HOSE BARB ELBOW 1/4 INCH NPT X 3/8 HOSE BARB
HBSSSEL1814	304 STAINLESS ELBOW 1/8 INCH NPT X 1/4 INCH HOSE BARB
HHPB3414	HEX HEAD POLY REDUCER BUSHING 3/4 X 1/4
HHSB1238	HEX HEAD S.S. REDUCER BUSHING 1/2in X 3/8
HV60	1/2in STAINLESS BALL VALVE - w/ WELDED NUT

NV14Y	FLOW CONTROL VALVE - INCLUDES BLACK KNOB
NV14Y-HNDL	BLACK KNOB FOR NEEDLE VALVE - 2839-1/4
P203CT	PLASTIC INJECTOR KIT INCLUDES INJECTOR - INTAKE HOSE - FOOT STRAINER AND WEIGHT - TIP KIT
P56	5700 PUMP WITH SANTOPRENE SEALS - INCLUDES HOSE BARBS, AIR FITTING, AND AIR PORT
P56K	5700 PUMP WITH KALREZ SEALS - INCLUDES HOSE BARBS, AIR FITTING, AND AIR PORT
P56V	FLOJET G57 PUMP WITH VITON - INCLUDES HOSE BARBS, AIR FITTING, AND AIR PORT
20756103B	Polypro G57 Air Port x HB Straight, w/ Viton o-ring
HB14P	1/4in BRASS HB AIR FITTING /G57/P56
HB5638	HOSE BARB FOR P56 PUMP
HB5638K	HOSE BARB FOR P56K PUMP
HB5638V	HOSE BARB FOR P56V PUMP
P56-BRKT	PUMP BRACKET- STAINLESS STEEL
P56-BRKT-SCREW	HI LO SCREW FOR RETAINING P56-BRKT
PLPF-B	BLANK PORTABLE FOAMER PLATE WITH HINGE W/O HOLES
PLPF-PIN	302 STAINLESS PORTABLE PLATE HINGE PIN
PVCV34FM	PVC VALVE 3/4in FPT X 3/4in MPT
PW10	3/4in BLACK POLY PRO X 10in - FPTBE - SCH.80
R25	AIR REGULATOR - 1/4ftpt TWO PORT 1/8ftpt TWO PORT - INCLUDES FILTER AND BOWL
ABR25	METAL AIR BOWL for R25
AFR25	AIR FILTER for R25
S142058-VS	1/4-20 X 5/8 PHIL TRUSS MACHINE SCREW 18-8 W/#516 VIBRASEAL ORANGE PATCH
S5161812	5/16-18 x 1/2 Phil Pan 18-8
SN1212	1/2in HEX STAINLESS STEEL NIPPLE
SSA14	SS304 MALE/FEMALE ADAPTOR 1/4 NPT X 1/4 NPT
SSAXLE581858	SS Axle T304 5/8in dia. x 18.625 (+/-0.063) 2 - 11/64in holes .130in (+/-0.015in) from each end
SSC34	WORM GEAR CLAMP, S/S (.75-1.25)
SSC38	WORM GEAR CLAMP, S/S (.25-.63)
SSMESH	STAINLESS STEEL MESH- 1 ball
SSP12	STAINLESS STEEL AXLE PLATE - 2.5 inch X 1 inch - 2 HOLE
SSST	SCREEN DISC .687 DIA. 10 X 10 MESH @ .020 DIA. 300 SERIES S.S.
SST12HB38	STAINLESS TEE COMBO 1/2in FPT X 3/8 in BARB WITH SSST AND S.S. MESH
ST80200	VEEJET NOZZLE, 80200
STR38-IL	IN LINE STRAINER 3/8 BARB 20 MESH 304 STAINLESS EDPM GSKT
TANK-15N-C	15 GALLON CONCENTRATE TANK NATURAL IN COLOR
TANK-15NC-BRKT	14G SS BRACKET FOR TANK-15NC
TW916	1/2 INT TOOTH L/W 410SS
W15	NONMARKING WHEEL FOR PORTABLE UNITS
W387	S.S. 304 SPRAY WAND 3/8in MPT X 7in LONG - THREAD ON ONE END