

Bleed-Off Valves

For Cooling Towers

ABS

Fully ported ball valves motorized open spring return.

Max Fluid Temp..... 250°F
 1/2" 0-130 PSI
 3/4" 0-130 PSI
 1" 0-100 PSI
 Valve Body Brass
 Ball & Stem Chrome Plated
 Seals Teflon
 Shipping Weight 6 lbs
 Standard Electrical 120 VAC
 Sizes Available .. 1/2, 3/4, 1, 1.5, 2"
 *Use weather shield for outdoor

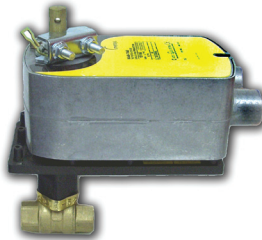

AEC

Paddle valves power opened and spring returned. (Reverse for higher pressure)

Max Fluid Temp..... 250°F
 1/2" 0-50 PSI
 3/4" 0-25 PSI
 1" 0-15 PSI
 Valve Body Brass
 Seat Brass
 Paddle Buna N
 Shipping Weight 3 lbs
 Standard Electrical 120 VAC
 Sizes Available 1/2, 3/4 & 1"

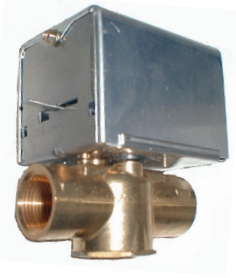

ABV

Fully ported ball valves motorized open spring return.

Max Fluid Temp..... 212°F
 1/2" 0-150 PSI
 3/4" 0-150 PSI
 1" 0-150 PSI
 2" 0-150 PSI
 Valve Body Nickel Plated Brass
 Ball & Stem Chrome Plated Brass
 Seals Teflon
 Shipping Weight 6 lbs
 Standard Electrical 120 VAC
 Sizes Available 1/2, 3/4, 1 & 2"
 *Use weather shield for outdoor

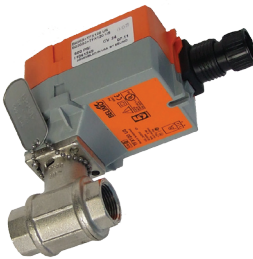

SO

Solenoid operated diaphragm valve

Max Fluid Temp..... 140°F
 Pressure 0-230 PSI
 Valve Body Brass
 Seat Viton
 Shipping Weight 3 lbs
 Standard Electrical 120 VAC
 Sizes Available 1/2, 3/4 & 1"

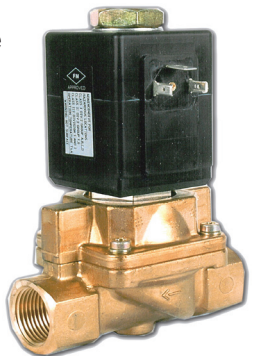

ABC

Ball valves motorized open capacitor return.

Max Temp..... 140°F
 Pressure 0-225 PSI
 Valve Body .. Chrome Plated Brass
 Ball & Stem Chrome Plated Brass
 Seals EPDM
 Shipping Weight 3 lbs
 Standard Electrical 120 VAC
 Sizes Available ... 1/4, 1/2, 3/4 & 1"
 **Shown with Option J



GE-SO

Basic solenoid operated diaphragm valve.

Max Fluid Temp..... 140°F
 Pressure 0-140 PSI
 Seat Viton
 Shipping Weight 3 lbs
 Standard Electrical 120 VAC
 GE-SO Sizes 1/2, 3/4 & 1"

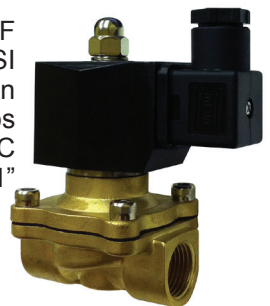

SGO / SG2

Solenoid operated diaphragm valve.
 Max Fluid Temp 140°F
 SGO 0-200 PSI
 SG2 * 2-300 PSI
 Valve Body Brass
 Seat Viton
 Shipping Weight 3 lbs
 Standard Electrical 120 VAC
 SGO Sizes 1/2, 3/4 & 1"
 SG2 Sizes 1/2, 3/4, 1, 1.5 & 2"
 * SG2-1/2" 300 psi
 * SG2-3/4 and 1" 230 psi
 * SG2-1.5 and 2" 150 psi



BL-3/4-BLK Bowl strainer
 Max Fluid Temp 120°F
 Max Pressure 120 PSI
 Head Polypropylene
 Bowl Nylon
 O-ring EPDM



ASCO

Solenoid operated diaphragm valve
 Max Fluid Temp 125°F
 1/2 & 3/4" 0-150 PSI
 1" 0-125 PSI
 Valve Body Brass
 Seat Buna N
 Shipping Weight 5 lbs
 Standard Electrical 120 VAC
 Sizes Available 1/2, 3/4 & 1"

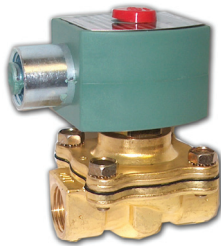

Pick your valve then make it a complete bleed-off assembly with option A.

Options

A adds poly strainer and shut-off
A1 adds metal y-strainer and shut-off
A4 adds poly y-strainer w/ flush and shut-off
J adds conduit box
Note: Option J required on ABC valves getting Option P
L UL listed coils on SG models
P Adds pre-wired 8' cord

Make installations easy with an assembly option

Advantage Controls offers a wide range of electrically activated valves for bleed-off of cooling tower water to complement your controller selection.

Choose from solenoid valves, motor open-spring or capacitor return ball valves or paddle valves.

Make maintenance easy by turning your selected bleed-off valve into a pre-assembled bleed-off assembly complete with shut-off valve and strainer with option A.

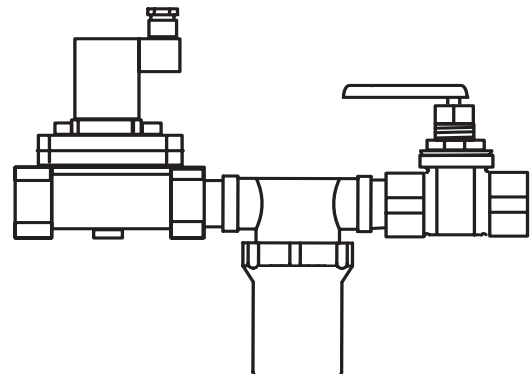

Get the Advantage



4700 Harold Abitz Dr
 Muskogee, OK 74403
 800-743-7431 phone
 888-686-6212 fax
www.advantagecontrols.com